



RF Components

IP67 2-Way L-Band Passive Splitter/Combiner

850 - 2450 MHz

Model Number:
ODU-2543

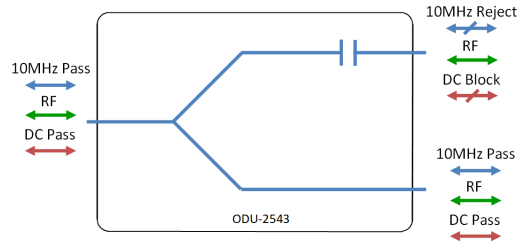

- One port DC & 10MHz pass
Other DC & 10 MHz blocked

Available with RF connector options:

- 50 Ω SMA
- 50 Ω N-type
- 50 Ω TNC

Compact & Waterproof
Housed in IP67 rated waterproof enclosure*



850-2450 MHz
Operating frequency range. L-Band ready

Flexible Mounting
Through hole mounting options

RF Parameters				
ODU-2543-XXXX		S5S5	N5N5	T5T5
Frequency Range		850 - 2450MHz		
RF Connectors		50Ω SMA	50Ω N-Type	50Ω TNC
Mean Insertion Loss (dB)		0.4 ± 0.2	0.4 ± 0.2	0.4 ± 0.2
Flatness ± (dB)		0.25	0.25	0.25
Input Return Loss (dB)	Typ.	20	20	20
	Min	16	16	16
Output Return Loss (dB)	Typ.	26	26	26
	Min	18	18	18
Isolation (dB)	Typ.	25	25	25
	Min	20	20	20
Amplitude Balance (dB)		≤0.5	≤0.5	≤0.5

The given Insertion Loss specified is the loss above the theoretical limit for a lossless divider
 10MHz Insertion Loss is up to 3dB above the theoretical loss*
 10MHz Rejection is 20dB*
 *To ports which are applicable

Broadcast



Marine Oil & Gas



SNG & VSAT



Satellite Teleport



Technical specifications and operating parameters

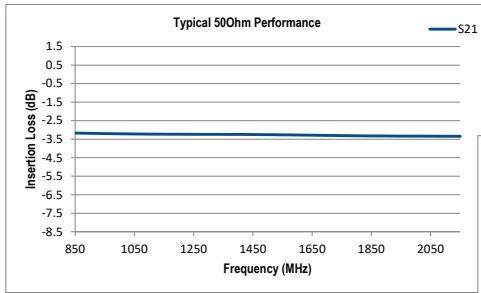

Insertion Loss

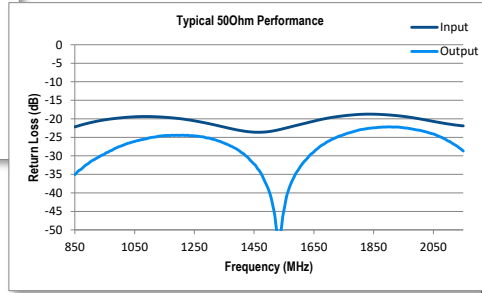

Return Loss

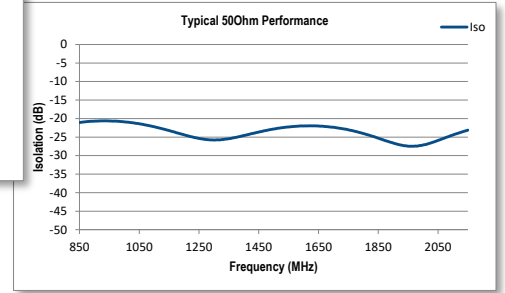

Isolation

Environmental		
Operating Temperature		-40 to +85 °C
Storage Temperature		-50 to +100 °C
Location		Indoor/Outdoor IP67* use
Humidity	Max.	100% non-condensing
Altitude	Max.	12,000 feet Operational 40,000 feet Survival

Max Operating Parameters	
Input RF Power into matched load with 20dB return loss	+37dBm (5W) as splitter +27dBm (500mW) as combiner
DC Voltage	35V on any RF port
DC Current (pass)	3A
DC Consumption	N/A

*IP67 integrity is maintained by populating all ports with sufficiently rated connectors and that unused ports have IP67 terminators or dust caps when awaiting connection. Dust caps are not sold with this product.

! Operation beyond these limits may cause instantaneous and permanent damage.

Physical Dimensions (mm)

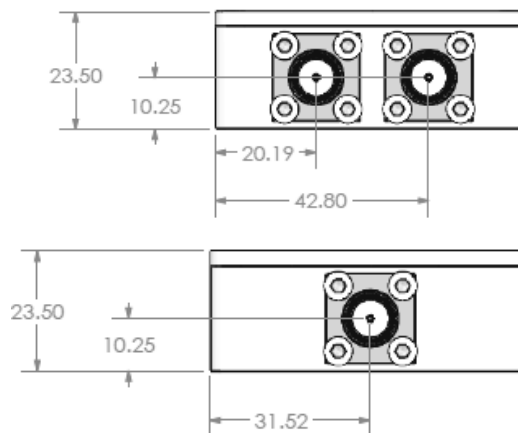
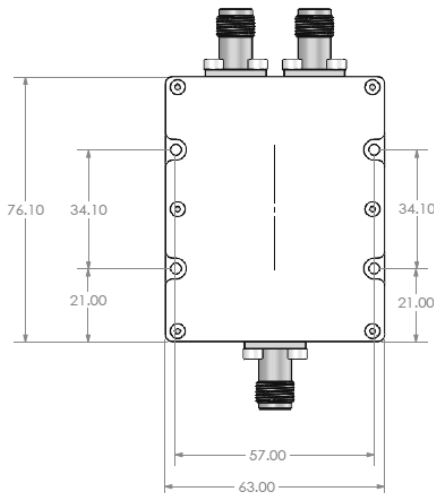

Note: The specification is subject to regular reviews and will be updated from time to time as part of our continuing product development and improved specification accuracy.